

MONO CRYSTALLINE HALF-CUT MODULE

360 / 365 / 370 / 375 / 380 Watts

Panther Series

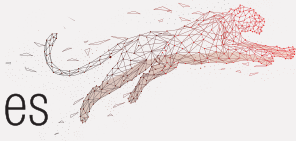

Overview

Ground breaking technology; higher power output, improved system performance - the ideal solution for end users who want a fast turnaround on their investments. A fully certified premium quality and high efficiency module made with A Grade materials.

Key Benefits

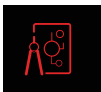

Certified by Independent Engineering Bodies



Product Liability Insurance



Ultra High Power Output

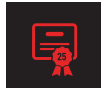

25 Years Limited Product Warranty



Low Resistive Losses



Low LCOE

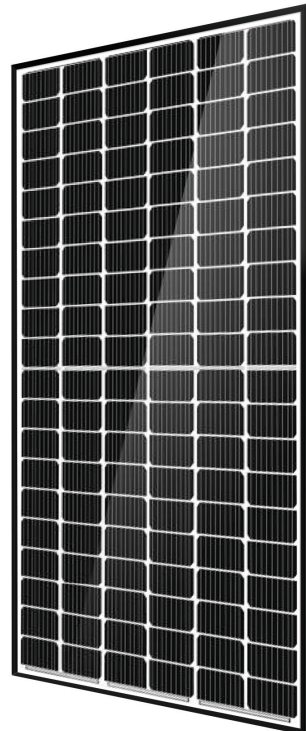

Guaranteed mechanical resistance to severe weather conditions



Positive Tolerance



100 % electro-luminescence tested

Tests, Certifications and Warranties

Standard Tests	IEC 61215, IEC 61730
Factory Quality Tests	ISO 9001: 2015, ISO 14001: 2015
Certifications	Conformity to CE, PV CYCLE Fire safety Class C according to UL790
Insurance	Third party liability insurance provided by Liberty Mutual
Wind and Snow Loads Testing	Module certified to withstand extreme wind (2400 Pascal) and snow loads (5400 Pascal)
Power Tolerance	Guaranteed +0/+5W (STC condition)
Warranties	<ul style="list-style-type: none"> • 25-year limited product warranty • 15-year manufacturer warranty on 91.70% of the nominal performance • 25-year transferable linear power output warranty

Linear Performance Warranty

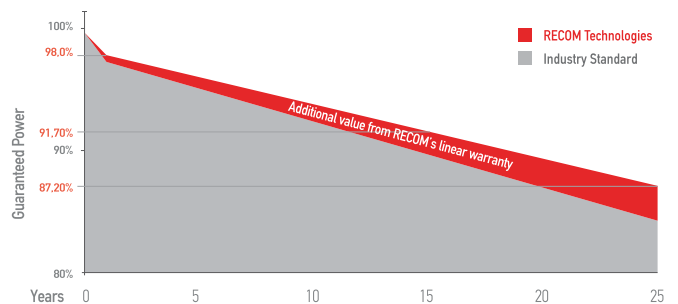

First Year Output $\geq 98\%$ 2-25 Year Decline $\leq 0.45\%$ 25 Year Output $\geq 87.20\%$

Panther

MONO CRYSTALLINE HALF CUT MODULE

RCM-xxx-6ME (xxx=360-380)

Electrical Characteristics

POWER CLASS ⁽¹⁾			360		365		370		375		380	
Testing Condition			STC ⁽²⁾	NMOT ⁽³⁾	STC	NMOT	STC	NMOT	STC	NMOT	STC	NMOT
Maximum Power	P _{max}	[Wp]	360	270	365	274	370	277	375	281	380	285
Maximum Power Voltage	V _{mp}	[V]	33.70	31.30	33.90	31.50	34.10	31.60	34.30	31.80	34.50	32.00
Maximum Power Current	I _{mp}	[A]	10.69	8.64	10.77	8.71	10.86	8.77	10.95	8.84	11.04	8.91
Open Circuit Voltage	V _{oc}	[V]	40.90	38.40	41.10	38.50	41.30	38.70	41.50	38.90	41.70	39.10
Short Circuit Current	I _{sc}	[A]	11.20	9.09	11.28	9.17	11.37	9.19	11.46	9.21	11.55	9.23
Module Efficiency	Eff	[%]	19.50	14.60	19.70	14.80	20.0	15.00	20.30	15.20	20.50	15.40
Maximum Series Fuse	I _R	[A]	20									
Maximum System Voltage	V _{sys}	[V]	1000 / 1500 (IEC)									

(1) Measurement Tolerances: P_{max} (± 3%), I_{sc} & V_{oc} (± 3%) - Power Classification 0/+5W
 (2) STC (Standard Testing Condition): Irradiance 1000W/m², Cell Temperature 25°C, AM 1.5
 (3) NMOT (Nominal Operating Module Temperature): Irradiance 800W/m², NMOT, Ambient Temperature 20°C, AM 1.5, Wind Speed 1m/s

Mechanical Data

Dimensions	1765mm x 1048mm x 30mm
Weight	20.0 Kg
Cell Type	Mono Perc - 166mm x 83mm (2 x 60 Pcs) - M6
Front Glass	3.2mm Tempered and low iron glass + ARC
Rear Side	Anti-aging film (White)
Frame	Anodized Aluminium Alloy (Black)
Junction Box	IP68 - 3 Bypass Diodes
Connector	MC4 compatible
Output cable	4mm ² - Landscape: P 1100mm Portrait: N 150mm/P 300mm or customized

Dimensions

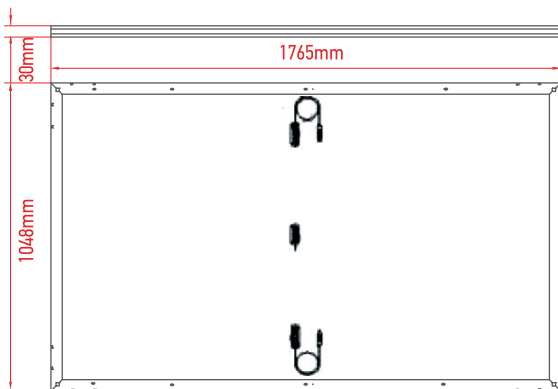

RECOM assumes no liability or responsibility for any typographical error, layout error, misinformation, any other error, omission, contained herein.

www.recom-tech.com

I-V Curve

The module relative power loss at low light irradiance of 200W/m² is less than 3%.

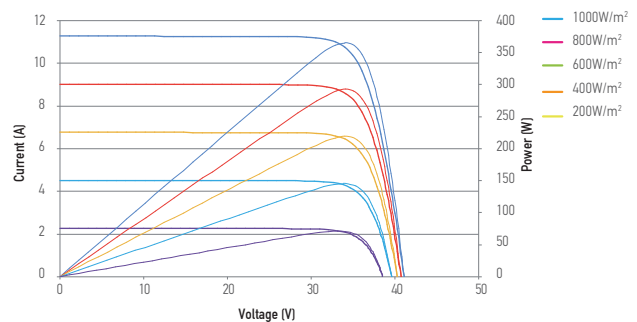

Temperature Characteristics

P _{max} Temperature Coefficient	-0.36% / °C
V _{oc} Temperature Coefficient	-0.28% / °C
I _{sc} Temperature Coefficient	+0.05 % / °C
Operating Temperature	-40 ~ +85 °C
Nominal Operating Module Temperature (NMOT)	42 ± 2 °C

Packing Configuration

Container	40' (HC)
Pieces per Pallet	36
Pallets per Container	26
Pieces per Container	(36+36+5)x13=1001

The specification and key features described in this datasheet may deviate slightly and are not guaranteed. Due to on-going innovation, research and product enhancement, RECOM Technologies reserves the right to make any adjustment to the information described herein at any time without notice. Please always obtain the most recent version of the datasheet which shall be duly incorporated into the binding contract made by the parties governing all transactions related to the purchase and sale of the products described herein. Please read the safety and installation instructions before using the modules.